



Tracking Solution User Guide

Team Mechanics

Assembly Instructions

Table of content

The Be Traced kit	7
Power Supply	8
Mounting of the Roof Antenna.....	9
Mounting the unit and its dimensions.....	13
Check for proper installation	15

Technical Note 1/2024

To all competitors and Teams,

This technical note is introduced in order to reduce the cases of incorrect installation of the BR001 device.

Careful installation and appropriate use of the device is **essential** to ensure the effective and safe monitoring of vehicles during competitions, failure to comply with the indications of this technical note could compromise the operation of the system.

All the main cases relating to the problems most frequently encountered in the tenders carried out in the first half of 2024 will be analysed below.

1) Powering the Device

The tracking device **must always be powered by the vehicle** to ensure continuous and reliable operation, it is **mandatory** to provide the device with a stable power supply with a voltage equal to or greater than **11 volts**.

It can be connected to the battery disconnect as long as it does not undergo voltage variations. The yellow wire (which allows the device to be switched on automatically) must be connected to the positive of the battery switch.



Figure 1 - White power light: device powered correctly



Figure 2 - Red power indicator light: device not powered

2) Proper installation and management of antenna cables (LTE, GNSS, IRIDIUM)

To ensure optimal signal reception and minimize interference, it is **mandatory** to follow these guidelines when installing the antenna:

- Cables (including those of the power supply) **cannot absolutely** pass next to heat sources: for example on the central tunnel if it heats up;
- Antenna cables **must not be twisted** or run with other cables that are sources of electromagnetic interference, such as control units, other power or intercom cables;
- The cables must **never** pass between the body and the rollbar;
- Check that the cables have not been **damaged** by passing through the hole in the roof;
- Excess cables should be left in the **back** of the vehicle, where there is no other equipment to avoid interference;
- The connectors of the antennas that reach the device **must be absolutely comfortable** and not be pulled, if the device changes position in the event of an impact they must not tear and must not remain tense while driving;
- **Do not tighten** the antenna connectors with pliers, tighten the connectors by hand checking the correct color match (LTE COLOR RED, GPS (GNSS) BLUE, IRIDIUM GRAY) (Figure 3).





Figure 3 - Antenna connectors

Particular attention is also required to the management of cables, which must not be damaged in any way: do not pull the cables or make splices, if the cable is damaged it is mandatory to buy a new antenna. After an accident or rollover, all antenna wiring and connectors should be checked again.

3) Potential problems and mistakes to avoid

Once the installation has been completed following the above instructions and/or during the race, the following problems may occur:

RED INDICATOR LIGHT ON THE DEVICE	MEANING	SOLUTION
	<p>Lack of power</p>	<ul style="list-style-type: none"> - Check the wiring; - Make sure you have followed the instructions in the installation manual; - Check the correct functioning of the vehicle's electrical system; - Check that the cable is properly connected.

	<p>Lack of GPS signal</p>	<ul style="list-style-type: none"> - Check the antenna cables; - Unscrew and screw the GPS signal connector back on correctly; - If the problem persists, contact Be Traced staff.
	<p>No communication with the Be Traced server</p>	<ul style="list-style-type: none"> - Check the antenna cables; - Unscrew and retighten the LTE signal connector correctly; - If the problem persists, contact Be Traced staff.
<p>The device keeps restarting</p>	<p>No external power and low battery</p>	<ul style="list-style-type: none"> - Review the power wiring; - Make sure you haven't reversed the polarity.

All crews are reminded that the number of the contact person to be contacted in the race field is given during the sporting checks of the race, you must **refer ONLY** to the number on the ticket delivered.

Should the system suffer a malfunction during a special stage or in transfer, it will be necessary to immediately and directly contact the Be Traced staff who will arrange for the replacement of the device as required with the Race Director.

4) Technical checks and Tracking System WARNING!!

During the technical checks, the **correct installation** of the BR001 device by our staff or by the Technical Stewards, its operation and the positioning of cables and antenna as per this technical note will be verified.

Crews with **non-compliant installations** will not be admitted to the technical checks until correct installation and confirmed operation.

Your complete cooperation is essential in order to ensure the safety of the crews.

5) Battery

At each special test CO, a spare backup battery has been provided to be applied to the device that does not receive proper vehicle power.

6) Battery-powered device

A battery-powered device has also been set up for each special stage CO to be added to the race one in the event of a malfunction of the main device.

The Be Traced kit

The Be Traced System Mounting Kit includes:

- 3-in-1 antenna, with roof mounting;
- Power cable with external interfaces;
- Ball attachment and articulated arm.



Fig. 1

ATTENTION: the kit does not include the device, which will be provided only at the end of the pre-race sporting and technical checks.

Power Supply

The Be Traced device requires external power supplied by the vehicle's battery, it allows 11 to 35 volts DC. It is mandatory to connect the power cable provided in the kit behind the battery cut-off, in order to be able to adequately supply power to the device.

Follow the diagram below (**Fig. 2**) to connect the device to the battery:

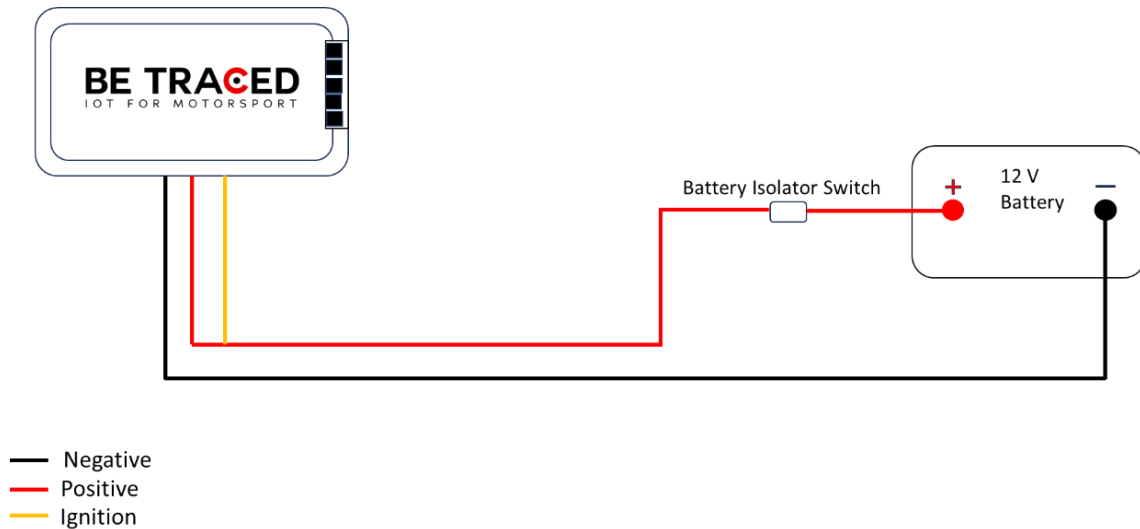

Fig. 2

The device is equipped with an internal battery that provides power in emergency situations where the vehicle's battery cannot be used.

When the device detects that it is stationary in "Transfer" mode and the stop is prolonged for more than 5 minutes, the device goes to sleep. Just click any button to turn on the device's screen again.

After a 15-minute "Transfer" stop without power, the device automatically shuts down. The device will turn on again as soon as power is supplied again.

Mounting of the Roof Antenna

The outdoor antenna must be properly installed on the roof of the vehicle to ensure proper data transmission.

The antenna is equipped with three different cables:

- Blue cable: dedicated to the GPS signal;
- Red cable: dedicated to the GSM network signal;
- Grey cable: dedicated to satellite communication.



Fig. 3: Roof antenna

The cables must be connected to the back of the device, respecting the writings above the connectors and the colors blue, red and gray, identifiable by a colored dot located on the device:



CAUTION: Make sure you have screwed the connectors to the device correctly.

To install the antenna, it is necessary to drill into the roof of the car to insert the cables and the underside of the antenna. The hole must have a diameter of 18 millimeters (**Fig. 4**). Once the roof of the vehicle has been drilled, unscrew the bolt and washer on the underside of the antenna, remove the protective film underneath and insert the antenna into the hole created. Once the antenna is inserted, reassemble the washer and bolt (washer first then bolt) and tighten the two items securely. Manage the cables to get them to the device, strictly avoiding passing them between the roll bar and the body, to avoid malfunctions in the event of an accident.

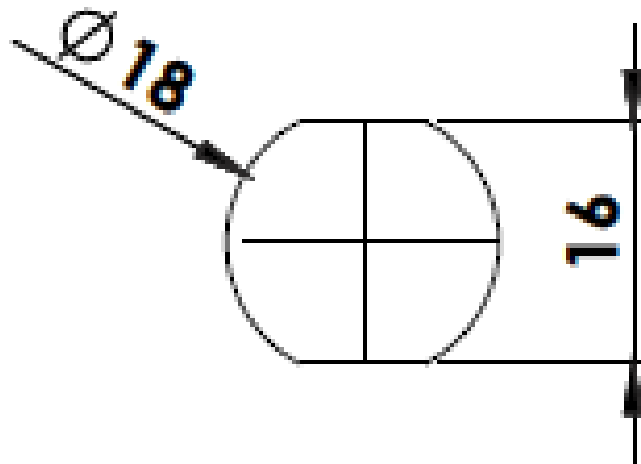

Fig. 4: Antenna hole measurement

Attention: ONLY for cars with a high historical value it is possible to apply the antenna on the rear window in plexiglass or in another position outside the vehicle, provided that the same has maximum visibility of the sky.

If the rear window is not oriented towards the sky it is necessary to use an L-shaped bracket or other types of bracket to be able to orient it horizontally.

In case the antenna through screw remains outside the vehicle, it is essential to isolate the hole in order to avoid the ingress of water inside the antenna with heat shrink sheath or with other adhesive tapes.



Fig. 5: Roof antenna installed on the vehicle

The recommended cable management is shown in the following images (**Fig.6, Fig.7, Fig.8, Fig.9**):



Fig. 6



Fig. 7



Fig. 8

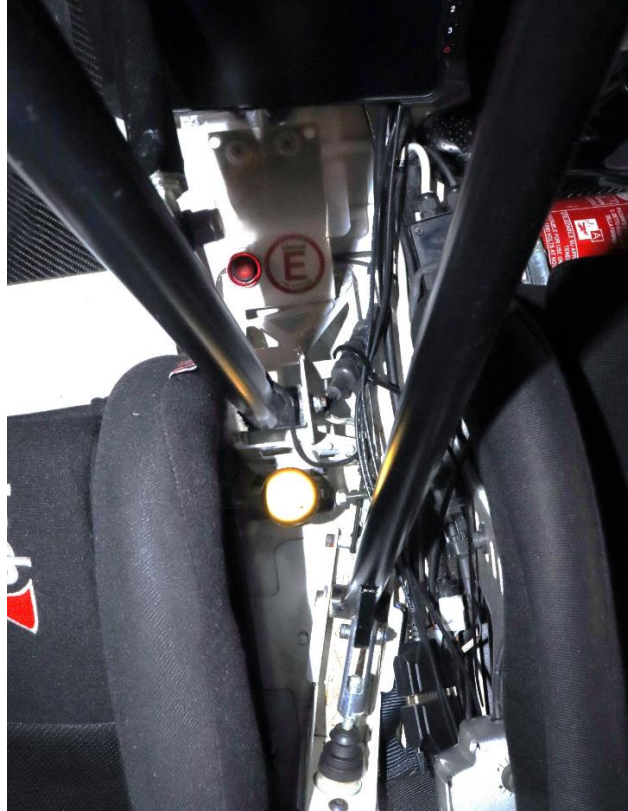

Fig. 9

Mounting the unit and its dimensions

Proper mounting of the unit must be done using the RAM mount included in the mounting kit. The stand is integrated with a ball that attaches to a small, fully adjustable arm. To adjust the arm and device, unscrew the nut on the arm.



Fig. 10



Fig. 11

The device has a length of 14 cm, width of 22 cm, thickness of 2 cm (**Fig.10**). It must be mounted in a central location and must be reachable by BOTH occupants of the vehicle. It is possible to orient the unit according to the crew's preference thanks to the RAM MOUNT arm which is fully adjustable.



Fig. 12

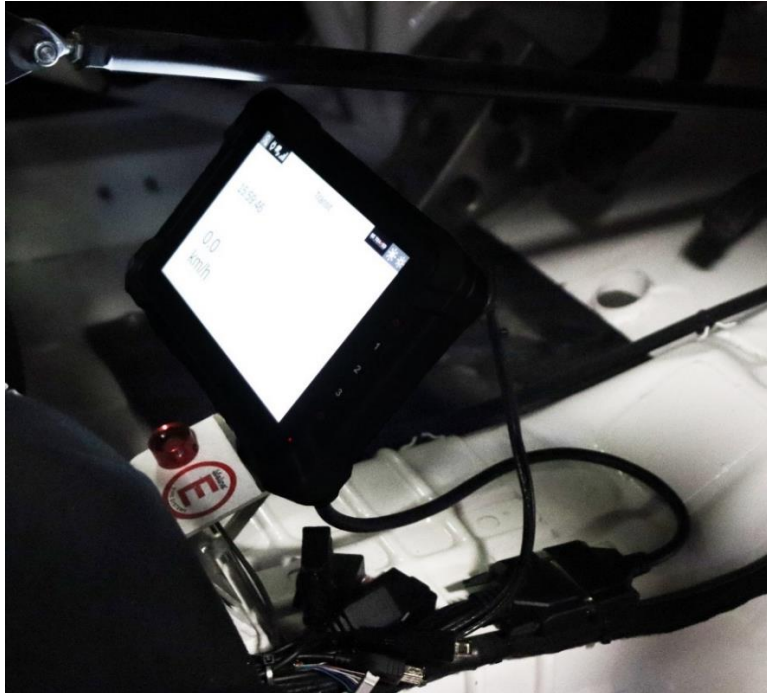

Fig. 13

Check for proper installation

To verify the correct installation of the device, once power is supplied, check the status of the device via the following icons:

1. External power supply, if the device is properly powered icon 1 will be displayed (**Fig.14**).
2. GPS signal, if the antenna is correctly connected, icon 2 is displayed (**Fig.14**).
3. Connecting to the Be Traced server, if the antenna is correctly connected and the device is correctly transmitting to the Be Traced server, icon 3 is shown in **Fig.14** (**Warning:** when the device is turned on, it takes a few moments to start transmitting correctly).

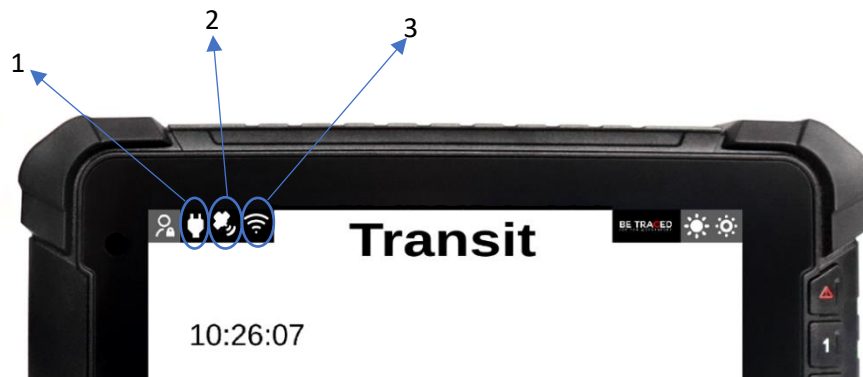

Fig. 14

Contacts

Fixup Srl

Via Guido Zadei, 45 25123 Brescia

030 2053201

motorsport@betraced.it

www.fixup.one

www.betraced.it